

## H3-TCM1-63AX+

10-6000MHz 50Ω 1:1 Balun

### APPLICATIONS

- differential modulator/demodulator and active mixers
- wideband push-pull amplifiers
- LTE, Cellular, PCS, UMTS, WiFi, WiMAX

### FEATURES

- Surface mount
- Impedance ratio: 1:1
- RoHS compliant and Pb free
- Available on tape and reel

### DIMENSIONS

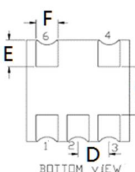
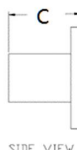
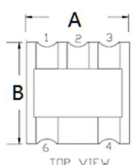

### Land Pattern

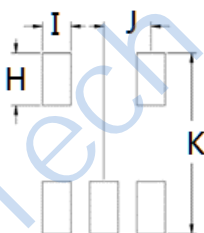

A	B	C	D	H	I	J
4.21	4.21	2.40	1.27	1.40	0.76	1.27
E	F	G	K			
1.11	0.90	2.00	4.83			

Unless otherwise stated dimensions are in mm

Tolerance: .xx ± 0.25, .xxx ± 0.05

### ELECTRICAL SPECIFICATIONS@25°C:

Parameters (P#: ENA PORT)	frequency band	Min.	Typ.	Max.	Unit
Port Impedance, Z0 (P1 / P2 / P3)			50 /25 25		Ohm
Insertion Loss	10-5000MHz		1.8	2.5	dB
	5000-6000MHz		2.4	3.0	dB
Amplitude Balance	10-6000MHz		0.5		dB
Phase Balance	10-6000MHz		8.0		Deg
Input Return Loss	10-6000MHz		13		dB

### TEST CURVE

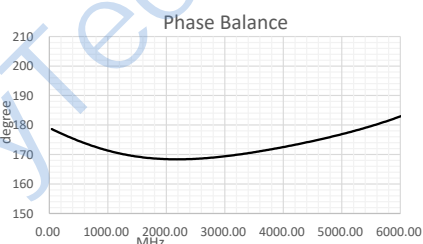
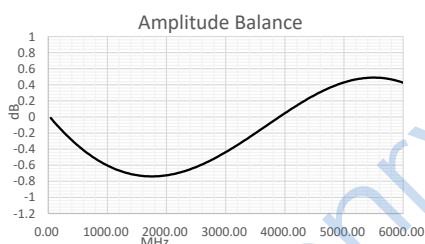
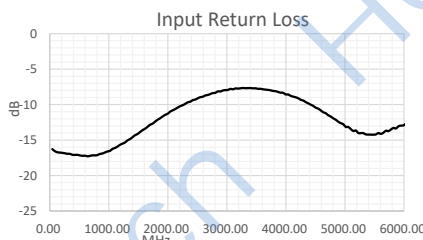

### FUNCTIONAL SCHEMATIC

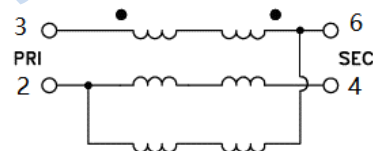

### PIN CONFIGURATION

Pin No.	Function
1	Not used
2	Primary
3	Primary Dot
4	Secondary
6	Secondary Dot

### APPLICATION & TEST CIRCUIT

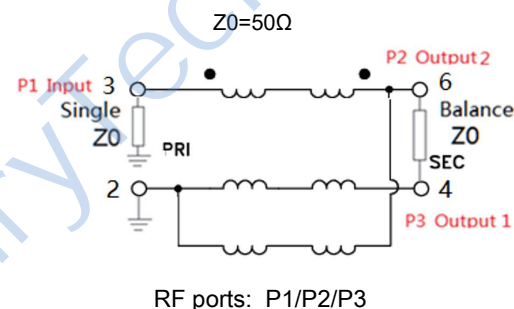

### ABSOLUTE MAXIMUM RATINGS

Parameter	Value
Input Power	200mW Max
DC Current	30mA Max
Operating Temperature Range	-40 to 85°C
Storage Temperature Range	-55 to 100°C

Tel: +86-28-85589664

E-mail: mr\_li@henglitaitech.com

Web: www.hltchips.com

Adress: No.198 Tianqin East Street, Gaoxin West District, Chengdu City